



L365-0304-1

*Quality & Service Since 1936*



# **Complete Wiring Instructions for LT36575 Lubricated Tank Mounted Compressor**

Section 1 - Introduction / Warnings

Section 2 - Wiring for Single Phase, Low Voltage

Section 3 - Wiring for Single Phase, High Voltage

Section 4 - Wiring for Three Phase, Low Voltage

Section 5 - Wiring for Three Phase, High Voltage

Call Toll Free

**1-800-345-8207**

or visit us on the web at

**[www.GENERALAIRPRODUCTS.com](http://www.GENERALAIRPRODUCTS.com)**

# Introduction

General Air Products, Inc. has been an industry leader in quality products and customer service since its creation in 1936. Our persistent effort in meeting the needs of our customers assures that we will continue to lead in these areas. In keeping with these ideals we bring you this comprehensive wiring manual.

Inside you will find pictures and detailed instructions on how to properly wire your LT36575\* Lubricated Tank Mounted Air Compressor.

If you have any questions or problems during the installation process please call us toll free at 1-800-345-8207.

## Warnings

- All electrical work must be completed by qualified electrical personnel, familiar with local and national codes.
- Motors are NOT factory wired. Connections for low or high voltage must be set by the installing personnel.
- Beware of long runs from the main power supply to the compressor, this can cause severe voltage drops. Voltage drops must be compensated for by increased wire size - consult factory for details.
- All units are controlled by a pressure switch. Ensure that the motor and incoming power supply are wired to the pressure switch.
- Magnetic Starters are recommended for all units and are required by electrical code for all 3 phase units.
- To ensure proper voltage to the compressor, a voltage reading MUST be taken while the compressor is running. We also recommend taking a voltage reading while the compressor is re-starting under load to verify the electrical service capacity.
- The current (amps) drawn by the compressor should be checked in conjunction with above. Starting and re-starting current loads will be higher initially than full load current. Our recommended wire sizes take this into account.
- Adjusting the pressure switch voids warranty - CONSULT FACTORY. Adjusting the pressure switch to a higher pressure could overload the motor.
- Beware - Capacitors hold voltage. Do not handle.
- Motors are NEMA rated, which means they will operate at +/-10% of name plate rating. The 10 percent applies to low and high voltage, but not 208v. This means motors wired for 208/230v will operate between 207v and 253v. **200v motors available - consult factory.**

**If you experience ANY electrical problems,  
contact the factory IMMEDIATELY by calling 1-800-345-8207**

# Wiring Instructions for LT36575 Section 2

Single Phase - Low Voltage (115v)

Model Number: LT36575A

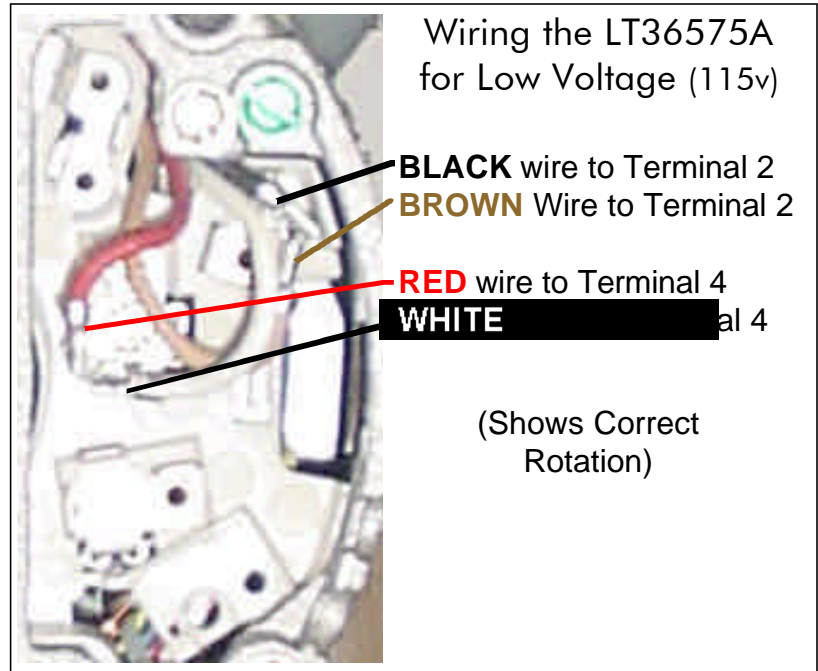
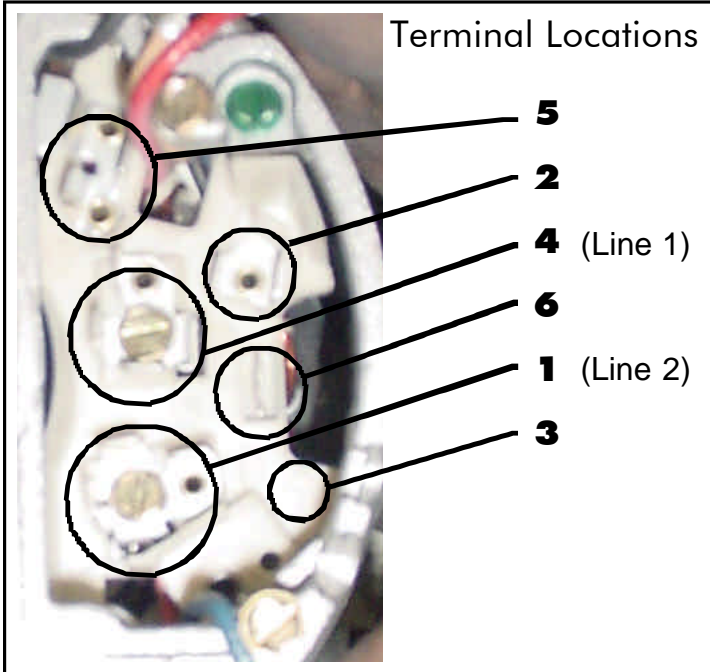

**Important Note:**

Diagrams show the interchange of the **BLACK** and **RED** leads for reverse rotation (proper rotation for this unit).

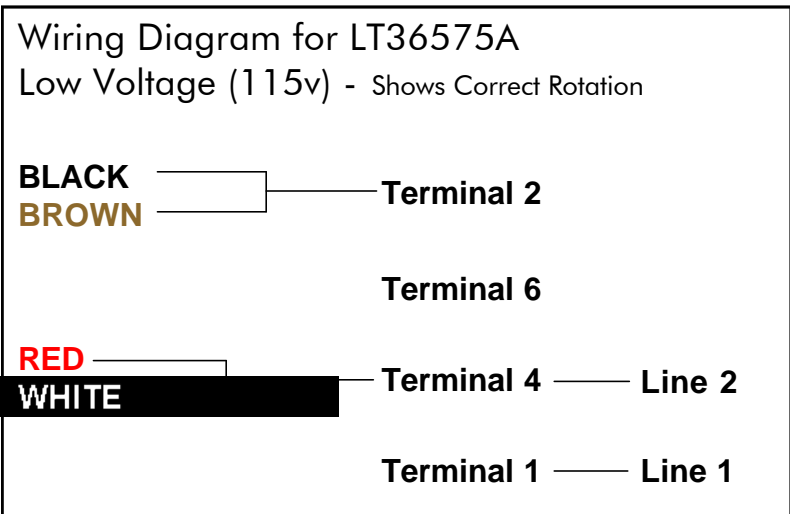

# Wiring Instructions for LT36575 Section 3

Single Phase - High Voltage (208-230v)

Model Number: LT36575A

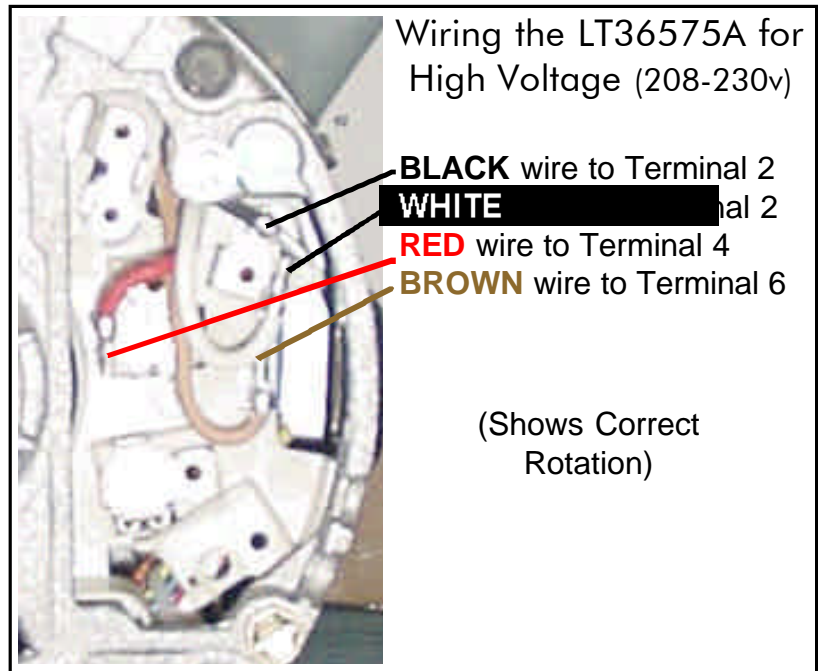
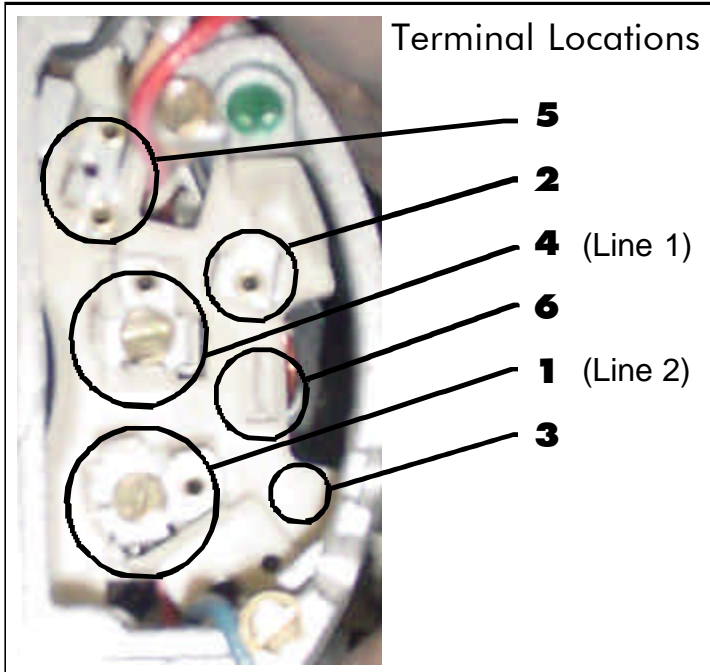

**Important Note:**

Diagrams show the interchange of the **BLACK** and **RED** leads for reverse rotation (proper rotation for this unit).

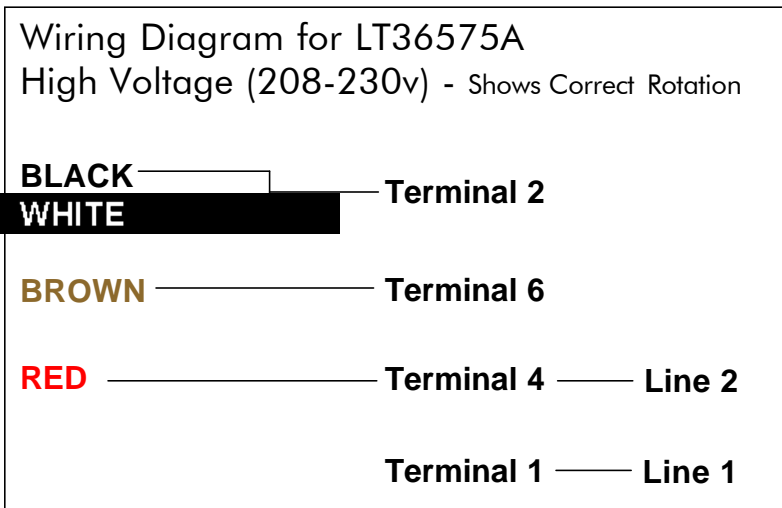

# Wiring Instructions for LT36575 Section 4

Three Phase - Low Voltage (208-230v)

Model Number: LT36575B

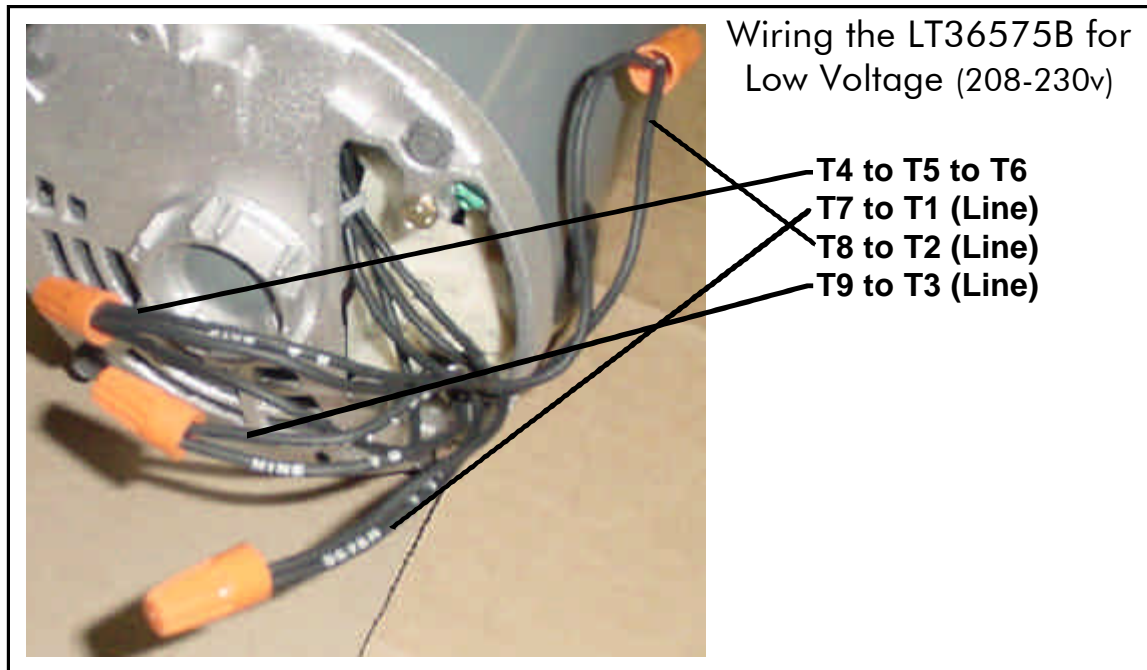

**Important Note:**

For correct rotation, interchange any of the three incoming wires (Line).

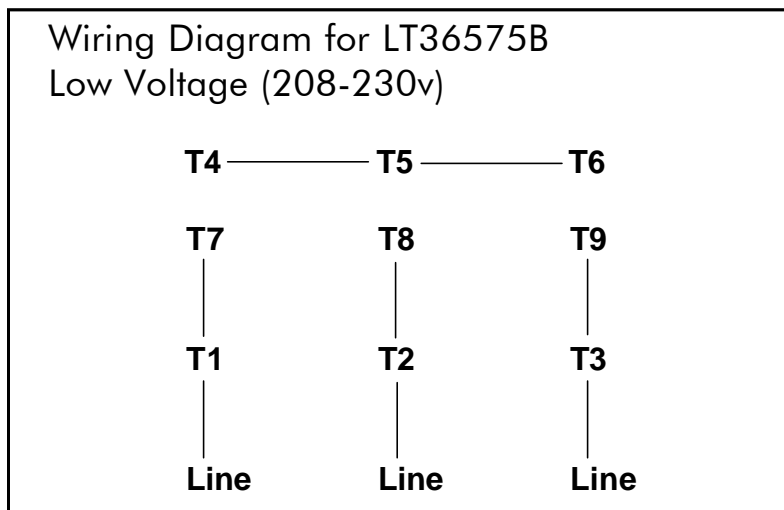

# Wiring Instructions for LT36575 Section 5

Three Phase - High Voltage (460v)

Model Number: LT36575B

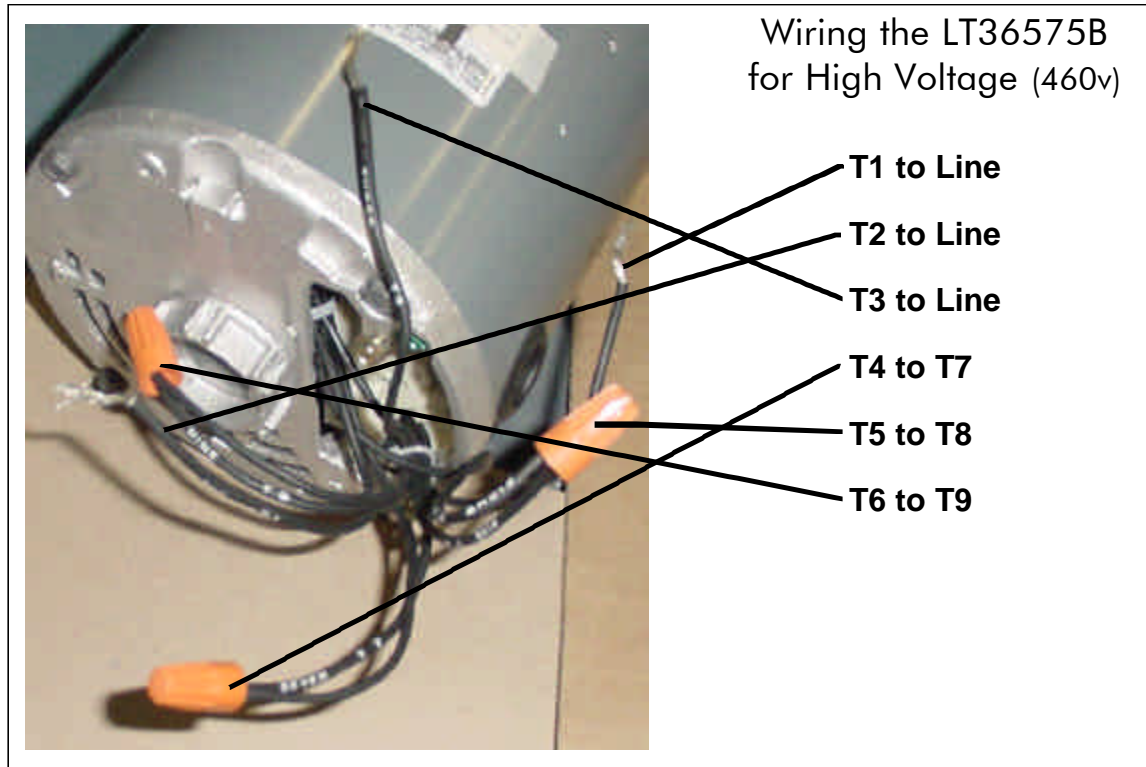

**Important Note:**

For correct rotation, interchange any of the three incoming wires (Line).

